

Lounge Pavilion,
by Kettal Studio

kettal

Description

Lounge Pavilion

Designer
Kettal Studio

Collection
Pavilions

Lounge Pavilion aims to be part of a project. It is not understood as an item apart, but instead relates to its environment and melds with it. It is the project that is important, not the product, and this is its essence. Its rationalist construction seeks to give order, form and structure to the outdoor space, although, in terms of function, it has been designed to give shelter: to shade and cool or protect from the rain and wind.

Scale
1/50

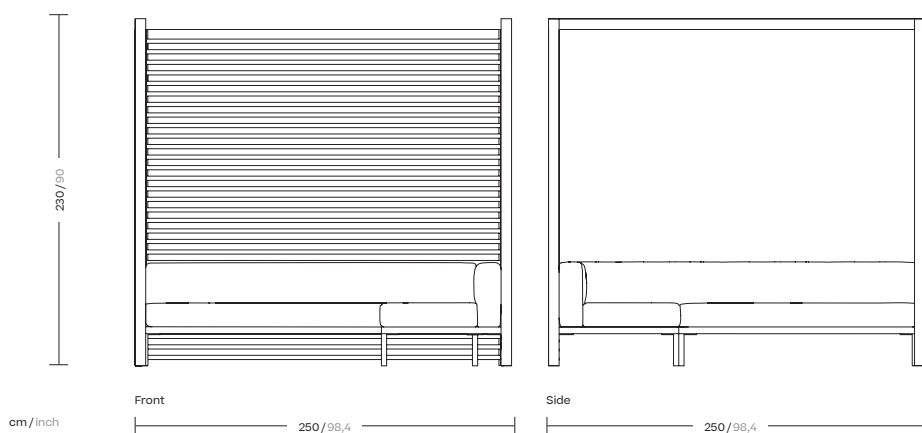

Isometric view

Lounge Pavilion

Designer
Kettal Studio

Collection
Pavilions

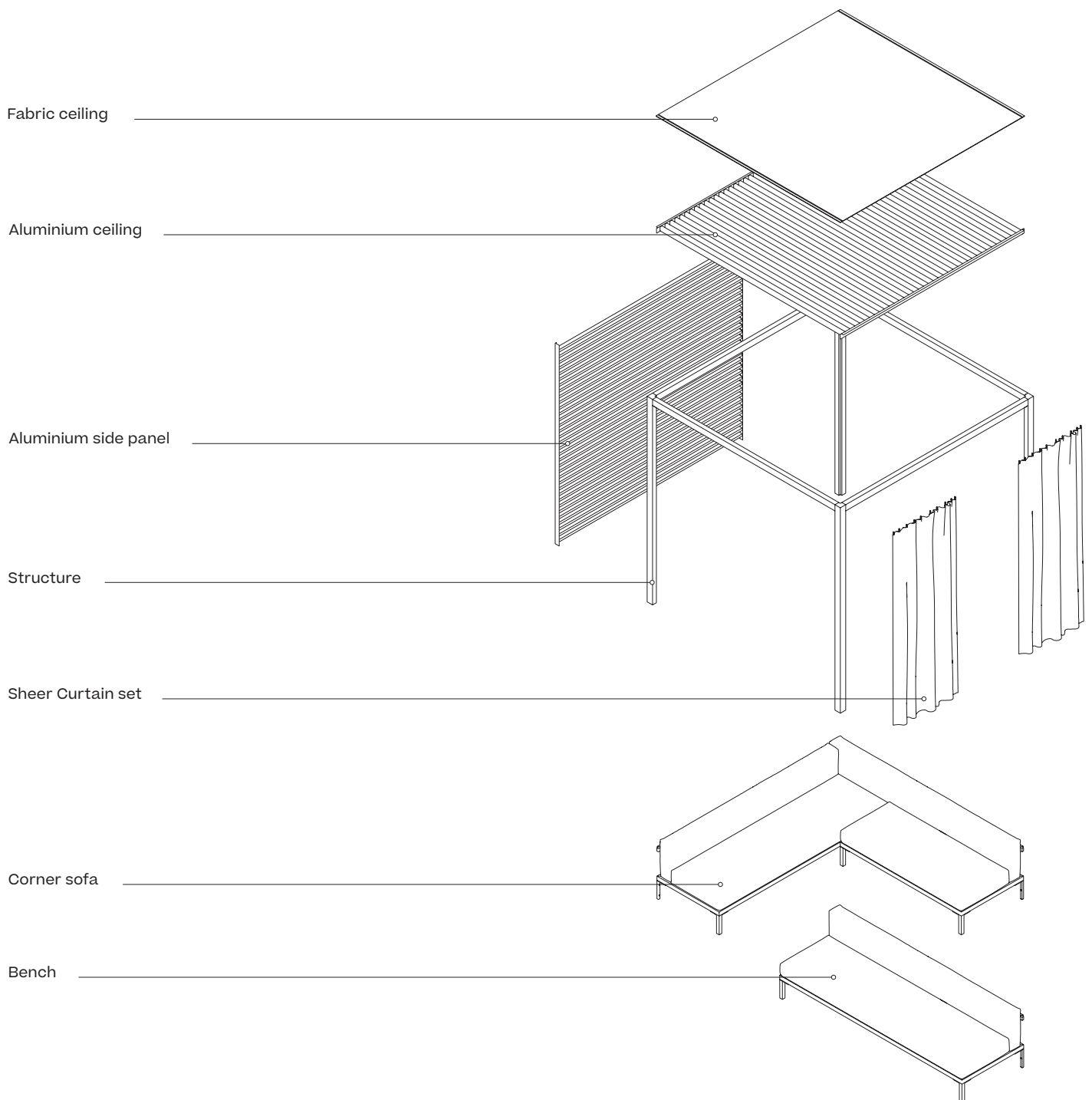

Instructions

1. Select frame.
2. Select ceiling.
3. Select side closure type.

Please consider incompatibilities shown in table.

Select code, then specify desired side.

Table of Compatibilities

S	Fabric Ceiling	Aluminium Ceiling	Seer Curtain Set	Aluminium Side Panel
Fabric Ceiling	NO	NO	YES	YES
Aluminium Ceiling	NO	NO	YES	YES
Seer Curtain Set	YES	YES	YES	YES
Aluminium Side Panel	YES	YES	YES	YES

Lounge Pavilion Structure



Simple



With Single Bench



With Corner Bench

Columns

This profile allows the side panels and anchoring base to be attached.
The material is aluminium alloy 6005 T6.

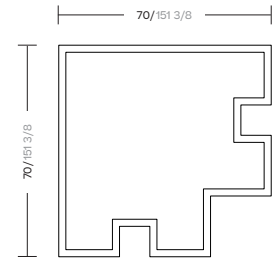

Corner Column

4,77 kg

Beams

The crossbeam described below is a profile with several slits that is used to attach the side panels and the roof.
The material is aluminium alloy 6005 T6.

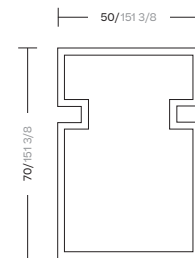

Simple Beam

6,1 kg

Footers

These elements are designed to provide a solid foundation, ensuring that the pavilion can withstand various weather and terrain conditions.

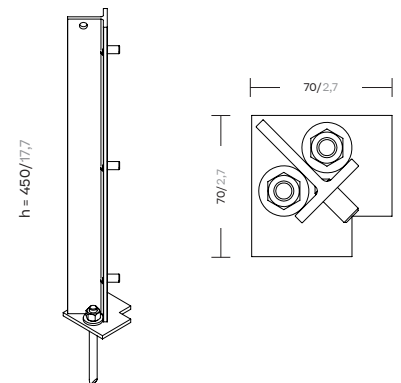

Corner Column

Finishes

Frame Color Options

Terrain Paints (for Aluminium)



Slate Stone
01C

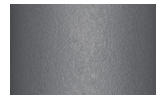

Mysty Smoke
02C



Ash
03C



Bone
04C



Tuff
05C



Wet Stone
06C



Sand Dune
07C



Dry Clay
08C



Arabica
09C



Sepia
19C



Rose Canyon
16C



Blossom
20C



Ruby Dust
18C



Sunset Glow
17C



Terrarosa
15C



Terracota
14C



Amber
13C



Ginger Root
12C



Desert Storm
11C



African Savannah
10C



Spring Meadow
28C

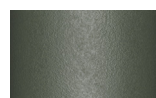

Kombu
29C



Forest Stream
27C



Sea Moss
26C



Glacier Ice
25C



Polar Sky
24C



Nightfall
23C

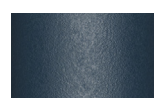

Indigo
22C

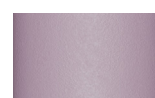

Wild Lupin
21C



Galena
33C



Bronze
30C



Corten
31C

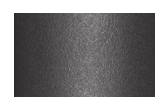

Manganese
32C

Ceiling / Side Panels

Aluwood



Atlantic White
Cedar
930



Western Red
Cedar
920



Smoked
Wenge
910

Finishes

Bench

Terrain Laminate Elements



Charcoal
01L

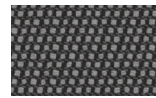

Cumulus
02L

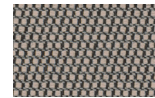

Fog
09L

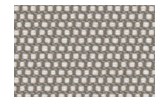

Porous Grey
08L



Snowcap
03L



Moonstone
07L



Karakum
06L



Cambium
12L



Raku
11L



Clove
13L



Desert Rose
14L



Pink Salt
15L



Pacific Dawn
16L



Acer
17L



Firetail
18L

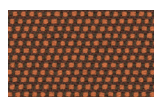

Glowing Ember
19L

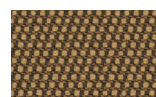

Tiger Eye
05L



Goldrush
04L

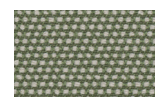

Sea Heart
22L

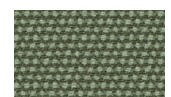

Heath
21L



Peppercorn
20L

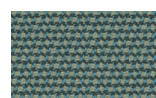

Rock Pool
23L



Tropic
24L

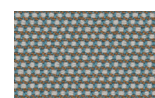

Skylark
25L

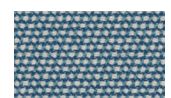

Nautica
26L

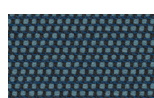

Blue Reef
27L



Cosmos
28L



Amethyst
29L

Finishes

Bench

Tonale Lino

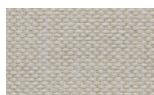

White Chia
61L-61T



Fennel
62L-62T



Elwendia
63L-63T



Brown Mustard
64L-64T



Kampot
65L-65T



Fenugreek
66L-66T

Bench

Tonale Boucle

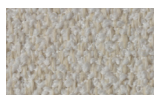

White Poppy
81L-81T



Sesame
82L-82T

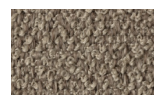

Anise
83L-83T

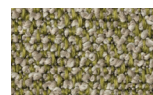

Dill
84L-84T



Allspice Jamaica
85L-85T

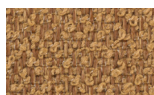

Birds Foot
86L-86T

Common

The columns described below are components used in both standard and bioclimatic pavilions. This means that the sides are compatible in both cases. The difference, however, is that the bioclimatic column is machined at the bottom for the drain.

Profile with two slits that allow the side panels and anchoring base to be attached
The material is aluminium alloy 6005 T6

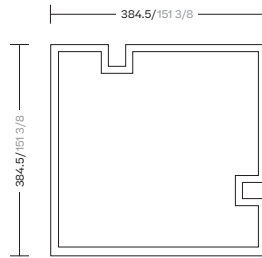

Corner Column

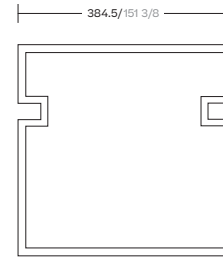

Central Double
Column

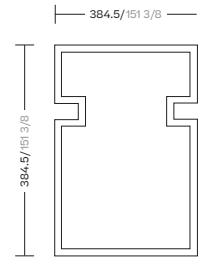

Auxiliary
Column
Not considered
structural

Materials

Chenilletex Fabric, Dyed Acrylic sheer curtain,
Aluminium Electro-paint, Chenilletex Fabric,
Dyed Acrylic sheer curtain, Aluminium Electro-
paint

Optical colours

Chenilletex Fabric, Dyed Acrylic sheer curtain,
Aluminium Electro-paint, Chenilletex Fabric,
Dyed Acrylic sheer curtain, Aluminium Electro-
paint